

Unità motocondensante - Condensing unit  
Verdichter-Verflüssiger-Einheit - Groupe de condensation

**BA**

Dimensioni - Dimensions - Maße - Dimensions	mm	<b>2.900x1.000x1.460H</b>
Peso - Weight - Gewicht - Poids	kg	<b>1.160</b>
Ø OUT/IN evap. - Ø OUT/IN evap. - Ø AUS/EIN Verd. - Ø OUT/IN evap.	mm	<b>64/28</b>
Ø IN/OUT cond. - Ø IN/OUT cond. - Ø EIN/AUS Verfl. - Ø IN/OUT cond.	mm	<b>42/28</b>
Ricevitore di liquido - Liquid receiver - Kältemittelsammler - Bouteille de liquide	l	<b>50</b>
Numero compressori - Compressor number - Anzahl Verdichter - Nombre compresseurs	#	<b>3</b>
Circuiti frigoriferi - Refrigerant circuits - Kältekreise - Circuits frigorifiques	#	<b>1</b>
Potenza motore - Motor power - Motorleistung - Puissance moteur	HP	<b>13,0</b>
Costruttore - Manufacturer - Hersteller - Fabricant		<b>DWM Copeland Scroll</b>
Modello - Model - Typ - Modèl		<b>ZS 92 K4E</b>

Resa frigorifera totale in kW - Total cooling capacity rating in kW  
Gesamtkälteleistung des in kW - Puissance frigorifique totale en kW

t <sub>c</sub>	t <sub>e</sub>				Condizioni operative - Operating conditions*
	0	-5	-10	-15	
+30	113,94	96,24	80,94	67,68	20 °C temperatura gas aspirato; 0 K sottoraffreddamento
+40	98,97	83,76	70,62	59,25	20 °C suction gas return; 0 K liquid subcooling
+50	83,10	70,44	59,52	50,04	20 °C sauggas temperatur; 0 K flüssigkeitsunterkühlung
					20 °C gaz aspirés; 0 K sous-refroid. de liquide

Dati elettrici globali - Global electric datas - Elektrische Gesamtwerte - Données électriques globales

Alimentazione - Power supply - Anschluß - Alimentation	V/~ / Hz	<b>400 / 3+N / 50</b>
Potenza max. ass. - Max. abs. power - Max. Leistungsaufn. - Puissance max.abs.	kW	<b>28,70</b>
Corrente max. ass. - Max. abs. current - Max. Stromaufn. - Courant max.abs.	A	<b>73,8</b>

\* Resa frigorifera come dichiarato dai costruttori dei compr. secondo ISO 12900 - Cooling capacity as indicated by the compress. manufactures according to ISO 12900  
Kälteleistung gemäß Herstellerangaben nach ISO 12900 - Puissance frigorifique coome indiqué par les constructeurs des compresseurs selon ISO12900

## MT CP SN

-12/+45 °C subcooling 3°C; superheating 10°C

Modello Model Modell Modelle	Compressore Compressor Compresseur Verdichter	Q -12/+45°C R404A [kW]	P max 400V - 3+N - 50Hz [kW]	I max [A]	Dati dimensionali - Dimensional datae Dimensional daten - Dimensional données				Connessioni frigorifere - Refrigerant connections Kälteleitungsanschlüsse - Connexions frigorifique				
					Structure	A [mm]	B [mm]	H [mm]	Weight [kg]	To condenser [mm]	From cond. [mm]	To users [mm]	From users [mm]
MT CP 2X4 SN	ZS 30 K4E	12,76	5,89	16,4	BA	1.750	800	1.460	580	22	16	16	28
MT CP 2X5 SN	ZS 38 K4E	15,56	7,36	21,4	BA	1.750	800	1.460	620	22	16	16	28
MT CP 2X6 SN	ZS 45 K4E	18,60	8,83	27,2	BA	2.100	900	1.460	695	22	16	16	35
MT CP 2X8 SN	ZS 56 K4E	22,46	11,04	30,8	BA	2.100	900	1.460	740	28	18	22	42
MT CP 2X10 SN	ZS 75 K4E	31,42	14,72	42,8	BA	2.100	900	1.460	810	35	22	22	42
MT CP 2X13 SN	ZS 92 K4E	39,24	19,14	49,2	BA	2.100	900	1.460	880	35	28	22	54
MT CP 3X4 SN	ZS 30 K4E	19,14	8,83	24,6	BA	2.100	900	1.460	750	28	16	16	35
MT CP 3X5 SN	ZS 38 K4E	23,34	11,04	32,1	BA	2.100	900	1.460	810	28	22	22	42
MT CP 3X6 SN	ZS 45 K4E	27,90	13,25	40,8	BA	2.100	900	1.460	845	28	22	22	42
MT CP 3X8 SN	ZS 56 K4E	33,89	16,56	46,2	BA	2.100	900	1.460	920	35	22	22	54
MT CP 3X10 SN	ZS 75 K4E	47,13	22,08	64,2	BA	2.900	1.000	1.460	1.070	42	28	28	54
MT CP 3X13 SN	ZS 92 K4E	58,86	28,70	73,8	BA	2.900	1.000	1.460	1.160	42	28	28	64
MT CP 4X4 SN	ZS 30 K4E	25,52	11,78	32,8	BA	2.900	1.000	1.460	1.050	28	16	16	35
MT CP 4X5 SN	ZS 38 K4E	31,12	14,72	42,8	BA	2.900	1.000	1.460	1.090	35	22	22	42
MT CP 4X6 SN	ZS 45 K4E	37,20	17,66	54,4	BA	2.900	1.000	1.460	1.190	35	22	22	54
MT CP 4X8 SN	ZS 56 K4E	44,92	22,08	61,6	BA	2.900	1.000	1.460	1.230	42	28	28	54
MT CP 4X10 SN	ZS 75 K4E	62,84	29,44	85,6	BA	4.200	1.000	1.460	1.310	42	28	28	64
MT CP 4X13 SN	ZS 92 K4E	78,48	38,27	98,4	BA	4.200	1.000	1.460	1.430	42	28	28	64

Equilibratura olio compressori diretta - Direct compressor oil level regulation - Direkte Verdichterölniveauregulierung - Régulation directe du niveau l'huile des compresseur

Per il dimensionamento e la fornitura di condensatore ad acqua od aria remoto contattare il Ns. ufficio tecnico commerciale

For the dimensioning and the supply of the water condenser or the remote air condenser, please contact our technical-commercial office

Für die Auslegung und Lieferung wasser- oder luftgekühlter Verflüssiger setzen Sie sich mit unser technisch-kaufmännisches Büro in Verbindung



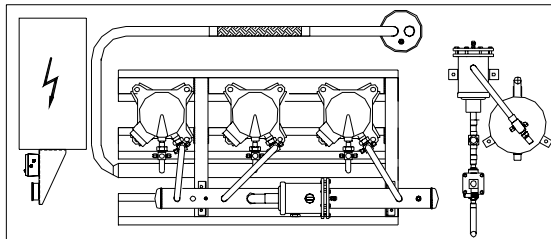
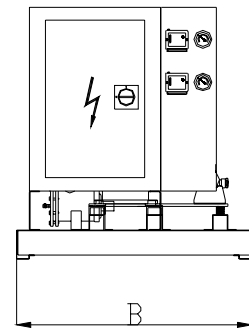
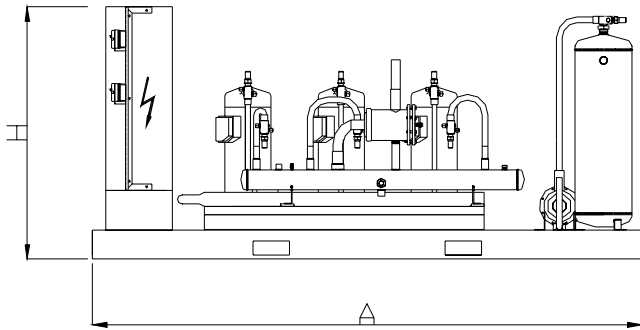



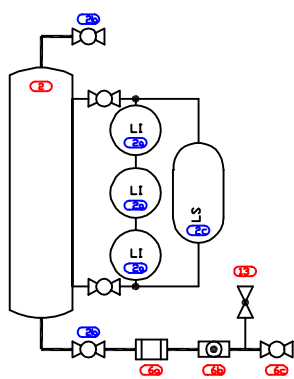
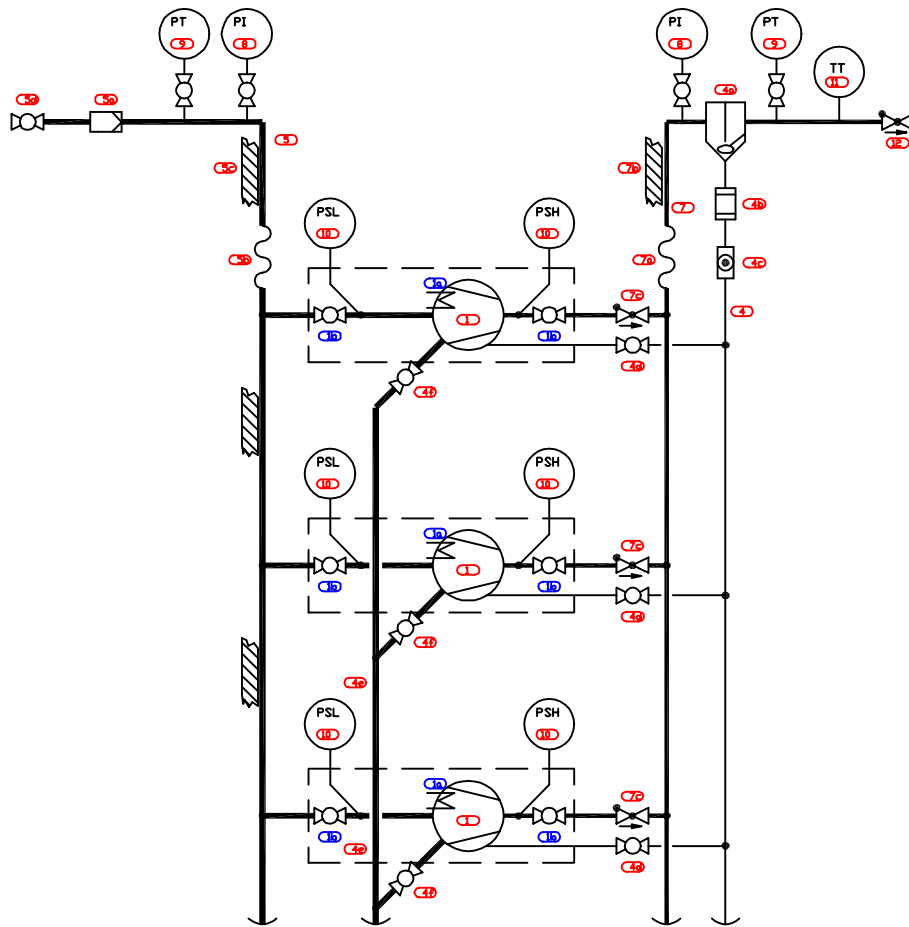



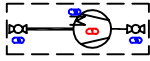









Pour la sélection et la fourniture de condenseurs à eau ou à air rémotes, contacter notre bureau technique-commercial



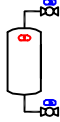







**Struttura - Structure - Gehäuse - Structure " BA "**



3 compressor Compressor Pack (LT & HT) - sneak concept with scroll compressors and oil equalizing

No.	Symbol	Description
1.		scroll compressor with equipment
2.		scroll compressor
3.		crankcase heater
4.		rotalock valve
5.		check valve
6.		shut-off valve
7.		suction filter
8.		insulation
9.		oil separator
10.		sightglass
11.		oil filter
12.		filter-drier
13.		liquid indicator (sight glass)
14.		service valve
15.		liquid receiver
16.		temperature sensor
17.		pressure sensor
18.		pressure indicator
19.		pressure switch low
20.		pressure switch high

Standard\_compressorpacks-sneak\_leg.dwg

21.		suction line
22.		discharge line
23.		liquid line
24.		oil line
25.		item no.
26.		subitem no.
27.		limits item with subitems
28.		level switch

Standard\_compressorpacks-sneak\_leg.dwg