

Unità motocondensante - Condensing unit
Verdichter-Verflüssiger-Einheit - Groupe de condensation

BA

Dimensioni - Dimensions - Maße - Dimensions	mm	1.400 x 700 x 1.260 H
Peso - Weight - Gewicht - Poids	kg	265
Ø OUT/IN evap. - Ø OUT/IN evap. - Ø AUS/EIN Verd. - Ø OUT/IN evap.	mm	28/16
Ø IN/OUT cond. - Ø IN/OUT cond. - Ø EIN/AUS Verfl. - Ø IN/OUT cond.	mm	22/18
Ricevitore di liquido - Liquid receiver - Kältemittelsammler - Bouteille de liquide	l	10
Numero compressori - Compressor number - Anzahl Verdichter - Nombre de compresseurs	#	1
Circuiti frigoriferi - Refrigerant circuits - Kältekreise - Circuits frigorifiques	#	1
Potenza motore - Motor power - Motorleistung - Puissance moteur	HP	7,5
Costruttore - Manufacturer - Hersteller - Fabricant		DWM Copeland Scroll
Modello - Model - Typ - Modèl		ZS 56 K4E

Resa frigorifera totale in kW - Total cooling capacity rating in kW
Gesamtkälteleistung des in kW - Puissance frigorifique totale en kW

T _c	t _e				Condizioni operative – Operating conditions*
	0	-5	-10	-15	
+30	22,07	18,56	15,53	12,91	20 °C temperatura gas aspirato; 0 K sottoraffreddamento
+40	19,18	16,16	13,55	11,29	20 °C suction gas return; 0 K liquid subcooling
+50	16,16	13,62	11,43	9,54	20 °C sauggas temperatur; 0 K flüssigkeitsunterkühlung
					20 °C gaz aspirés; 0 K sous-refroid. de liquide

Dati elettrici globali - Global electric datas - Elektrische Gesamtwerte - Données électriques globales

Alimentazione - Power supply - Anschluß - Alimentation	V/~ / Hz	400 / 3+N / 50
Potenza max. ass. - Max. abs. power - Max. Leistungsaufn. - Puissance max.abs.	kW	5,52
Corrente max. ass. - Max. abs. current - Max. Stromaufn. - Courant max.abs.	A	15,4

* Resa frigorifera come dichiarato dai costruttori del compr. secondo ISO 12900 - Cooling capacity as indicated by the compress. manufactures according to ISO 12900
Kälteleistung gemäß Herstellerangaben nach ISO 12900 - Puissance frigorifique coome indiqué par les constructeurs des compresseurs selon ISO12900

MT CP SN

-12/ +45 °C subcooling 3°C; superheating 10°C

Modello Model Modell Modèle	Compressore Compressor Compresseur Verdichter	Q -12/+45°C R404A [kW]	P max 400V - 3+N - 50Hz [kW]	I max [A]	Dati dimensionali - Dimensional data Dimensional data - Dimensional données				Connessioni frigorifere - Refrigerant connections Kälteleitungsanschlüsse - Connexions frigorifique				
					Structure	A [mm]	B [mm]	H [mm]	Weight [kg]	To condenser [mm]	From condenser [mm]	To evaporator [mm]	From evaporator [mm]
MT CP 8 SN	ZS 56 K4E	11,23	5,52	15,4	BA	1.400	700	1.260	265	22	18	16	28
MT CP 10 SN	ZS 75 K4E	15,71	7,36	21,4	BA	1.550	800	1.260	370	28	18	16	35
MT CP 13 SN	ZS 92 K4E	19,62	9,57	24,6	BA	1.550	800	1.260	390	28	18	16	35
MT CP D 2X8 SN	ZS 56 K4E	22,46	11,04	30,8	BA	1.750	800	1.460	440	22	18	16	28
MT CP D 2X10 SN	ZS 75 K4E	31,42	14,72	42,8	BA	2.100	900	1.460	545	28	18	16	35
MT CP D 2X13 SN	ZS 92 K4E	39,24	19,14	49,2	BA	2.100	900	1.460	570	28	18	16	35

Per il dimensionamento e la fornitura di condensatore ad acqua od aria remoto contattare il Ns. ufficio tecnico commerciale

For the dimensioning and the supply of the water condenser or the remote air condenser, please contact our technical-commercial office

Für die Auslegung und Lieferung wasser- oder luftgekühlter Verflüssiger setzen Sie sich mit unser technisch-kaufmännisches Büro in Verbindung



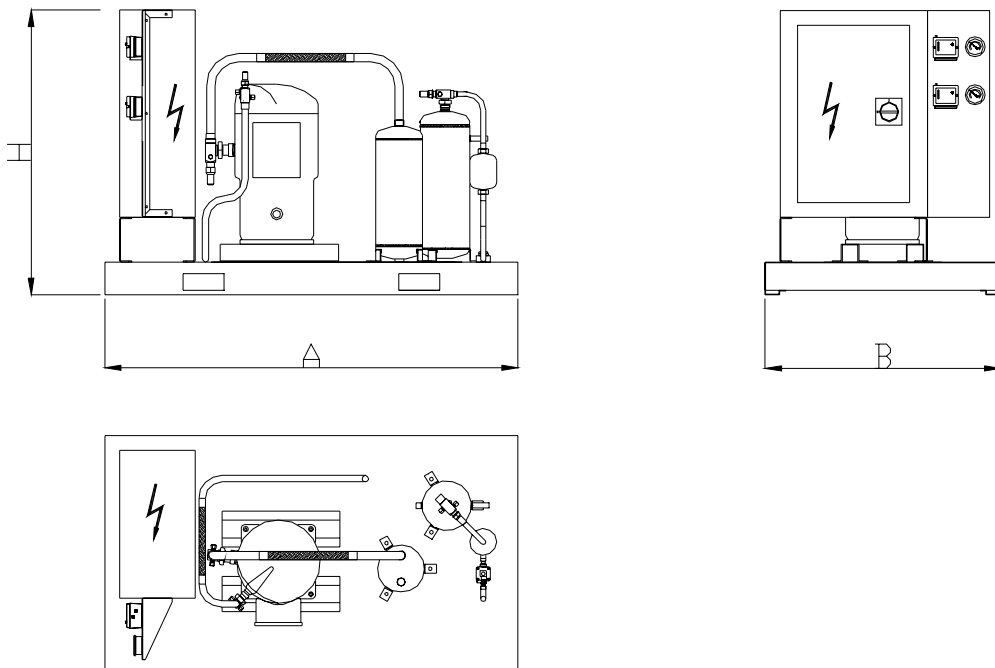



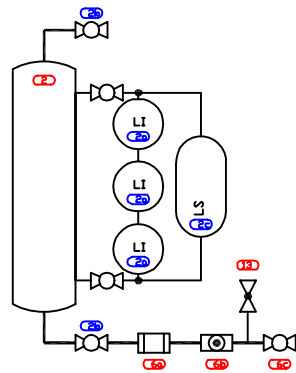
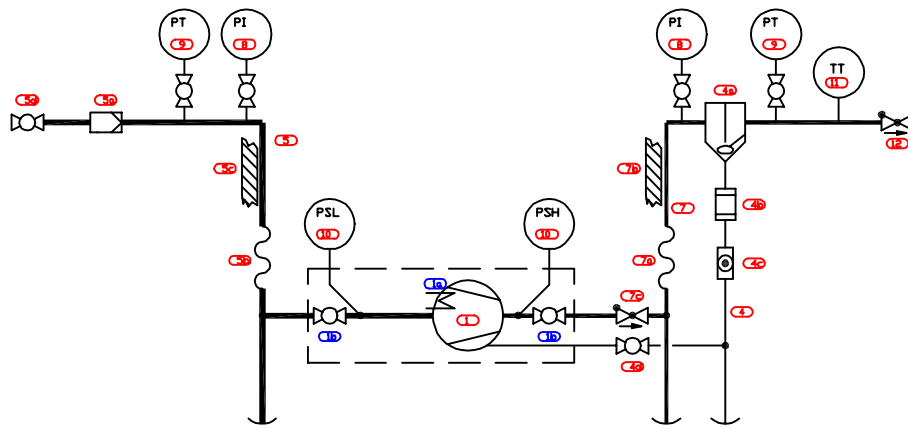



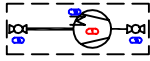









Pour la sélection et la fourniture de condenseurs à eau ou à air rémotes, contacter notre bureau technique-commercial



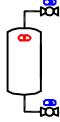







Struttura - Structure - Gehäuse - Structure " BA "



1 compressor Compressor Pack (LT & HT) - sneak concept
with scroll compressor

No.	Symbol	Description
1.		scroll compressor with equipment
2.		scroll compressor
3.		crankcase heater
4.		rotalock valve
5.		check valve
6.		shut-off valve
7.		suction filter
8.		insulation
9.		oil separator
10.		sightglass
11.		oil filter
12.		filter-drier
13.		liquid indicator (sight glass)
14.		service valve
15.		liquid receiver
16.		temperature sensor
17.		pressure sensor
18.		pressure indicator
19.		pressure switch low
20.		pressure switch high

Standard_compressorpacks-sneak_leg.dwg

21.		suction line
22.		discharge line
23.		liquid line
24.		oil line
25.		item no.
26.		subitem no.
27.		limits item with subitems
28.		level switch

Standard_compressorpacks-sneak_leg.dwg