

Unità motocondensante - Condensing unit  
 Verdichter-Verflüssiger-Einheit - Groupe de condensation

**BA**

|   |    |                              |
|---|----|------------------------------|
| Dimensioni - Dimensions - Maße - Dimensions   | mm | <b>1.550 x 800 x 1.260 H</b> |
| Peso - Weight - Gewicht - Poids   | kg | <b>370</b>                   |
| Ø OUT/IN evap. - Ø OUT/IN evap. - Ø AUS/EIN Verd. - Ø OUT/IN evap.                  | mm | <b>35/16</b>                 |
| Ø IN/OUT cond. - Ø IN/OUT cond. - Ø EIN/AUS Verfl. - Ø IN/OUT cond.                 | mm | <b>28/18</b>                 |
| Ricevitore di liquido - Liquid receiver - Kältemittelsammler - Bouteille de liquide | l  | <b>10,0</b>                  |
| Numero compressori - Compressor number - Anzahl Verdichter - Nombre de compresseurs | #  | <b>1</b>                     |
| Circuiti frigoriferi - Refrigerant circuits - Kältekreise - Circuits frigorifiques  | #  | <b>1</b>                     |
| Potenza motore - Motor power - Motorleistung - Puissance moteur                     | HP | <b>10,0</b>                  |
| Costruttore - Manufacturer - Hersteller - Fabricant                                 |    | <b>DWM Copeland Scroll</b>   |
| Modello - Model - Typ - Modèl   |    | <b>ZS 75 K4E</b>             |

 Resa frigorifera totale in kW - Total cooling capacity rating in kW  
 Gesamtkälteleistung des in kW - Puissance frigorifique totale en kW

| t <sub>c</sub> | t <sub>e</sub> |       |       |       | Condizioni operative – Operating conditions*            |
|----------------|----------------|-------|-------|-------|---|
|                | 0              | -5    | -10   | -15   |   |
| +30            | 30,51          | 25,84 | 21,76 | 18,20 | 20 °C temperatura gas aspirato; 0 K sottoraffreddamento |
| +40            | 26,79          | 22,61 | 18,99 | 15,83 | 20 °C suction gas return; 0 K liquid subcooling         |
| +50            | 22,47          | 18,91 | 15,86 | 13,24 | 20 °C sauggas temperatur; 0 K flüssigkeitsunterkühlung  |
|                |                |       |       |       | 20 °C gaz aspirés; 0 K sous-refroid. de liquide         |

Dati elettrici globali - Global electric datas - Elektrische Gesamtwerte - Données électriques globales

|  |          |                       |
|--|----------|-----------------------|
| Alimentazione - Power supply - Anschluß - Alimentation                         | V/~ / Hz | <b>400 / 3+N / 50</b> |
| Potenza max. ass. - Max. abs. power - Max. Leistungsaufn. - Puissance max.abs. | kW       | <b>7,36</b>           |
| Corrente max. ass. - Max. abs. Current - Max. Stromaufn. - Courant max.abs.    | A        | <b>21,4</b>           |

 \* Resa frigorifera come dichiarato dai costruttori del compr. secondo ISO 12900 - Cooling capacity as indicated by the compress. manufactures according to ISO 12900  
 Kälteleistung gemäß Herstellerangaben nach ISO 12900 - Puissance frigorifique coome indiqué par les constructeurs des compresseurs selon ISO12900

## MT CP SN

-12/ +45 °C subcooling 3°C; superheating 10°C

| Modello<br>Model<br>Modell<br>Modèle | Compressore<br>Compressor<br>Compresseur<br>Verdichter | Q<br>-12/+45°C<br>R404A<br>[kW] | P max<br>400V - 3+N - 50Hz<br>[kW] | I max<br>[A] | Dati dimensionali - Dimensional data<br>Dimensional data - Dimensional données |           |           |           | Connessioni frigorifere - Refrigerant connections<br>Kälteleitungsanschlüsse - Connexions frigorifique |                      |                        |                       |                         |
|--------------------------------------|--|---------------------------------|------------------------------------|--------------|--|-----------|-----------|-----------|--|----------------------|------------------------|-----------------------|-------------------------|
|                                      |  |                                 |                                    |              | Structure  | A<br>[mm] | B<br>[mm] | H<br>[mm] | Weight<br>[kg]   | To condenser<br>[mm] | From condenser<br>[mm] | To evaporator<br>[mm] | From evaporator<br>[mm] |
| <b>MT CP 8 SN</b>                    | ZS 56 K4E  | <b>11,23</b>                    | <b>5,52</b>                        | <b>15,4</b>  | BA   | 1.400     | 700       | 1.260     | 265  | 22                   | 18                     | 16                    | 28                      |
| <b>MT CP 10 SN</b>                   | ZS 75 K4E  | <b>15,71</b>                    | <b>7,36</b>                        | <b>21,4</b>  | BA   | 1.550     | 800       | 1.260     | 370  | 28                   | 18                     | 16                    | 35                      |
| <b>MT CP 13 SN</b>                   | ZS 92 K4E  | <b>19,62</b>                    | <b>9,57</b>                        | <b>24,6</b>  | BA   | 1.550     | 800       | 1.260     | 390  | 28                   | 18                     | 16                    | 35                      |
| <b>MT CP D 2X8 SN</b>                | ZS 56 K4E  | <b>22,46</b>                    | <b>11,04</b>                       | <b>30,8</b>  | BA   | 1.750     | 800       | 1.460     | 440  | 22                   | 18                     | 16                    | 28                      |
| <b>MT CP D 2X10 SN</b>               | ZS 75 K4E  | <b>31,42</b>                    | <b>14,72</b>                       | <b>42,8</b>  | BA   | 2.100     | 900       | 1.460     | 545  | 28                   | 18                     | 16                    | 35                      |
| <b>MT CP D 2X13 SN</b>               | ZS 92 K4E  | <b>39,24</b>                    | <b>19,14</b>                       | <b>49,2</b>  | BA   | 2.100     | 900       | 1.460     | 570  | 28                   | 18                     | 16                    | 35                      |

Per il dimensionamento e la fornitura di condensatore ad acqua od aria remoto contattare il Ns. ufficio tecnico commerciale

For the dimensioning and the supply of the water condenser or the remote air condenser, please contact our technical-commercial office

Für die Auslegung und Lieferung wasser- oder luftgekühlter Verflüssiger setzen Sie sich mit unser technisch-kaufmännisches Büro in Verbindung



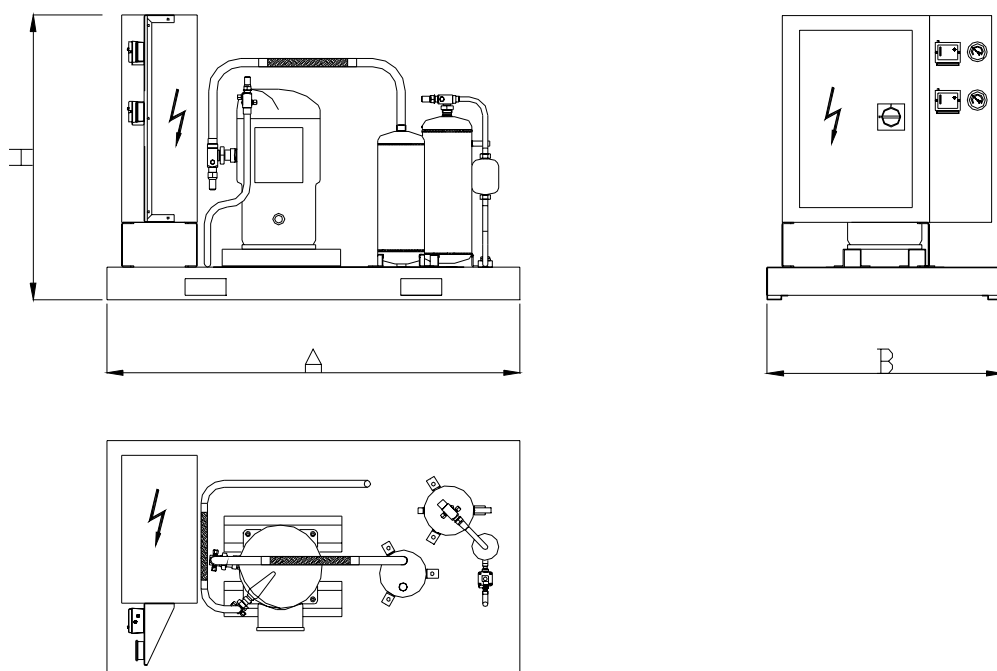



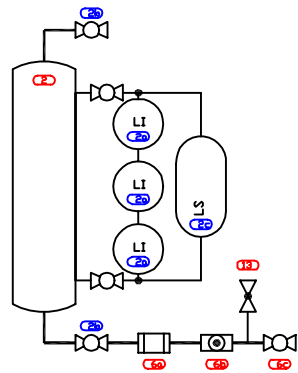
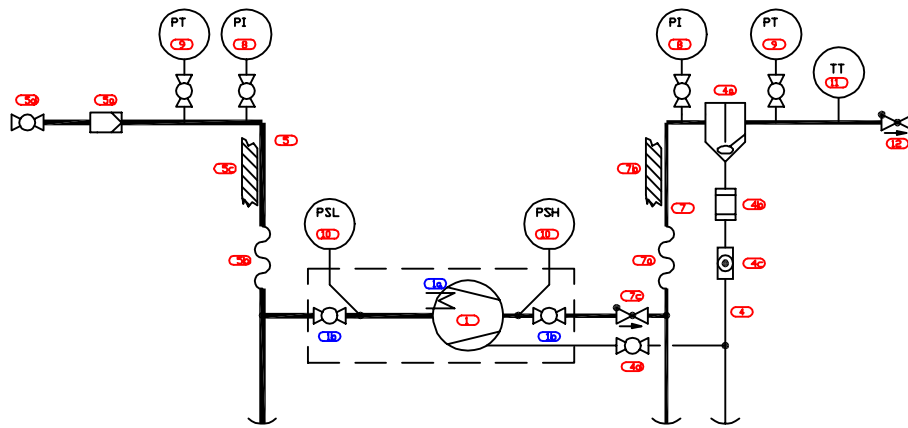



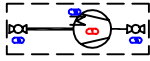









Pour la sélection et la fourniture de condenseurs à eau ou à air rémotes, contacter notre bureau technique-commercial



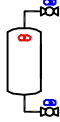







**Struttura - Structure - Gehäuse - Structure " BA "**



1 compressor Compressor Pack (LT & HT) - sneak concept with scroll compressor

| No. | Symbol  | Description                      |
|-----|---|----------------------------------|
| 1.  |    | scroll compressor with equipment |
| 2.  |    | scroll compressor                |
| 3.  |    | crankcase heater                 |
| 4.  |    | rotalock valve                   |
| 5.  |    | check valve                      |
| 6.  |    | shut-off valve                   |
| 7.  |    | suction filter                   |
| 8.  |    | insulation                       |
| 9.  |   | oil separator                    |
| 10. |  | sightglass                       |
| 11. |  | oil filter                       |
| 12. |  | filter-drier                     |
| 13. |  | liquid indicator (sight glass)   |
| 14. |  | service valve                    |
| 15. |  | liquid receiver                  |
| 16. |  | temperature sensor               |
| 17. |  | pressure sensor                  |
| 18. |  | pressure indicator               |
| 19. |  | pressure switch low              |
| 20. |  | pressure switch high             |

Standard\_compressorpacks-sneak\_leg.dwg

|     |   |                           |
|-----|---|---------------------------|
| 21. |  | suction line              |
| 22. |  | discharge line            |
| 23. |  | liquid line               |
| 24. |  | oil line                  |
| 25. |  | item no.                  |
| 26. |  | subitem no.               |
| 27. |  | limits item with subitems |
| 28. |  | level switch              |

Standard\_compressorpacks-sneak\_leg.dwg