

Unità motocondensante - Condensing unit
Verdichter-Verflüssiger-Einheit - Groupe de condensation

BA

Dimensioni - Dimensions - Maße - Dimensions	mm	1.750 x 800 x 1.460 H
Peso - Weight - Gewicht - Poids	kg	820
Ø OUT/IN evap. - Ø OUT/IN evap. - Ø AUS/EIN Verd. - Ø OUT/IN evap.	mm	35/16
Ø IN/OUT cond. - Ø IN/OUT cond. - Ø EIN/AUS Verfl. - Ø IN/OUT cond.	mm	28/16
Ricevitore di liquido - Liquid receiver - Kältemittelsammler - Bouteille de liquide	l	20
Numero compressori - Compressor number - Anzahl Verdichter - Nombre compresseurs	#	3
Circuiti frigoriferi - Refrigerant circuits - Kältekreise - Circuits frigorifiques	#	1
Potenza motore - Motor power - Motorleistung - Puissance moteur	HP	4,0
Costruttore - Manufacturer - Hersteller - Fabricant		DWM Copeland
Modello - Model - Typ - Modèle		ZF 13 K4E

Resa frigorifera totale in kW - Total cooling capacity rating in kW
Gesamtkälteleistung des in kW - Puissance frigorifique totale en kW

t _c	t _e				Condizioni operative – Operating conditions*
	-20	-25	-30	-35	
+30	18,09	14,79	11,94	9,45	20 °C temperatura gas aspirato; 0 K sottoraffreddamento
+40	15,81	12,93	10,44	8,34	20 °C suction gas return; 0 K liquid subcooling
+50	13,26	10,86	8,85	7,20	20 °C sauggas temperatur; 0 K flüssigkeitsunterkühlung
					20 °C gaz aspirés; 0 K sous-refroid. de liquide

Dati elettrici globali - Global electric datas - Elektrische Gesamtwerte - Données électriques globales

Alimentazione - Power supply - Anschluß - Alimentation	V/~ / Hz	400 / 3+N / 50
Potenza max. ass. - Max. abs. power - Max. Leistungsaufn. - Puissance max.abs.	kW	8,83
Corrente max. ass. - Max. abs. current - Max. Stromaufn. - Courant max.abs.	A	25,2

* Resa frigorifera come dichiarato dai costruttori dei compr. secondo ISO 12900 - Cooling capacity as indicated by the compress. manufactures according to ISO 12900
Kälteleistung gemäß Herstellerangaben nach ISO 12900 - Puissance frigorifique coome indiqué par les constructeurs des compresseurs selon ISO12900

LT CP SN

-37/ +45 °C subcooling 3°C; superheating 10°C

Modello Model Modell Modelle	Compressore Compressor Compresseur	Q -30/+40°C R404A [kW]	P max 400V - 3+N - 50Hz [kW]	I max [A]	Datii dimenzionali - Dimensional datae Dimensional datan - Dimensional données				Connessioni frigorifere - Refrigerant connections Kälteleitungsanschlüsse - Connexions frigorifique				
					Structure	A [mm]	B [mm]	H [mm]	Weight [kg]	To condenser [mm]	From cond. [mm]	To users [mm]	From users [mm]
LT CP 2X3 SN	ZF09 K4E	3,00	4,42	13,0	BA	1.750	800	1.460	582	22	12	12	28
LT CP 2X4 SN	ZF13 K4E	4,46	5,89	16,8	BA	1.750	800	1.460	626	22	12	12	28
LT CP 2X5 SN	ZF15 K4E	5,22	7,36	21,4	BA	1.750	800	1.460	747	22	16	16	35
LT CP 2X6 SN	ZF18 K4E	6,26	8,63	27,6	BA	1.750	800	1.460	890	28	16	16	35
LT CP 3X3 SN	ZF09 K4E	4,47	6,62	19,5	BA	1.750	800	1.460	757	22	12	12	35
LT CP 3X4 SN	ZF13 K4E	6,69	8,83	25,2	BA	1.750	800	1.460	820	28	16	16	35
LT CP 3X5 SN	ZF15 K4E	7,83	11,04	32,1	BA	2.100	900	1.460	864	28	22	22	42
LT CP 3X6 SN	ZF18 K4E	9,39	13,25	41,4	BA	2.100	900	1.460	932	35	22	22	42
LT CP 4X3 SN	ZF09 K4E	6,00	8,83	26,0	BA	2.900	1.000	1.460	1.060	28	16	16	35
LT CP 4X4 SN	ZF13 K4E	8,92	11,78	33,6	BA	2.900	1.000	1.460	1.120	28	22	22	42
LT CP 4X5 SN	ZF15 K4E	10,44	14,72	42,8	BA	2.900	1.000	1.460	1.170	35	22	22	42
LT CP 4X6 SN	ZF18 K4E	12,52	17,66	55,2	BA	2.900	1.000	1.460	1.210	35	22	22	54

Equilibratura olio compressori diretta - Direct compressor oil level regulation - Direkte Verdichterölniveauregulierung - Régulation directe du niveau l'huile des compresseur

Per il dimensionamento e la fornitura di condensatore ad acqua od aria remoto contattare il Ns. ufficio tecnico commerciale

For the dimensioning and the supply of the water condenser or the remote air condenser, please contact our technical-commercial office

Für die Auslegung und Lieferung wasser- oder luftgekühlter Verdichters setzen Sie sich mit unser technisch-kaufmännisches Büro in Verbindung



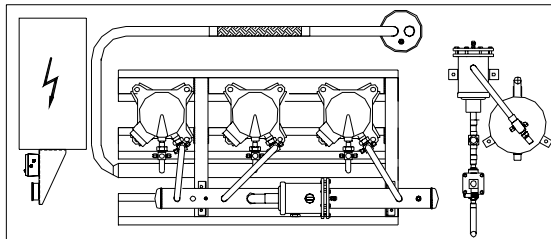
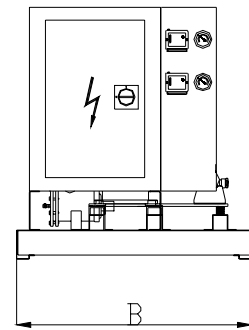
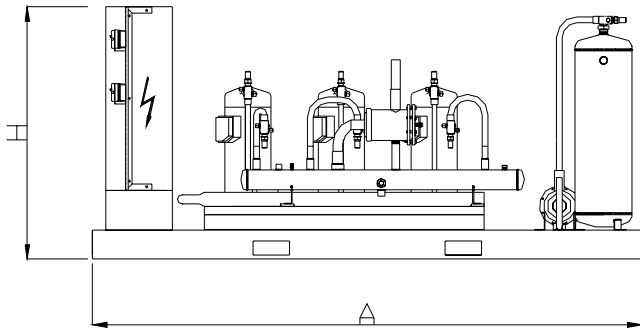



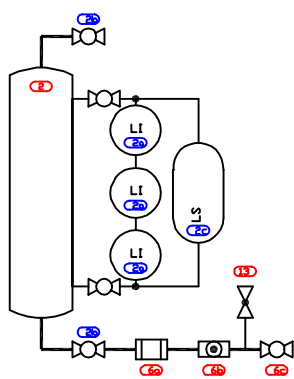
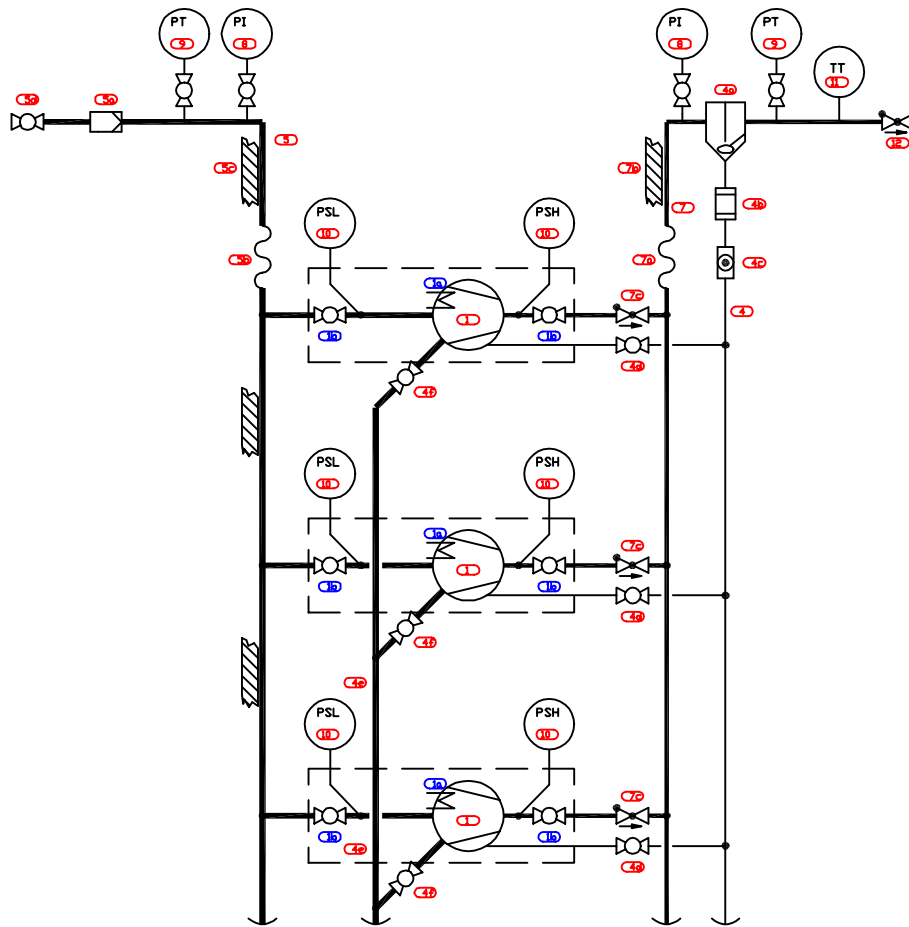



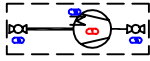









Pour la sélection et la fourniture de condenseurs à eau ou à air rémotes, contacter notre bureau technique-commercial



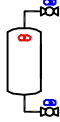







Struttura - Structure - Gehäuse - Structure " BA "



3 compressor Compressor Pack (LT & HT) - sneak concept with scroll compressors and oil equalizing

No.	Symbol	Description
1.		scroll compressor with equipment
2.		scroll compressor
3.		crankcase heater
4.		rotalock valve
5.		check valve
6.		shut-off valve
7.		suction filter
8.		insulation
9.		oil separator
10.		sightglass
11.		oil filter
12.		filter-drier
13.		liquid indicator (sight glass)
14.		service valve
15.		liquid receiver
16.		temperature sensor
17.		pressure sensor
18.		pressure indicator
19.		pressure switch low
20.		pressure switch high

Standard_compressorpacks-sneak_leg.dwg

21.		suction line
22.		discharge line
23.		liquid line
24.		oil line
25.		item no.
26.		subitem no.
27.		limits item with subitems
28.		level switch

Standard_compressorpacks-sneak_leg.dwg