

Unità motocondensante - Condensing unit
Verdichter-Verflüssiger-Einheit - Groupe de condensation

BA

| | | |
|---|----|------------------------------|
| Dimensioni - Dimensions - Maße - Dimensions | mm | 1.750 x 800 x 1.460 H |
| Peso - Weight - Gewicht - Poids | kg | 757 |
| Ø OUT/IN evap. - Ø OUT/IN evap. - Ø AUS/EIN Verd. - Ø OUT/IN evap. | mm | 35/12 |
| Ø IN/OUT cond. - Ø IN/OUT cond. - Ø EIN/AUS Verfl. - Ø IN/OUT cond. | mm | 22/13 |
| Ricevitore di liquido - Liquid receiver - Kältemittelsammler - Bouteille de liquide | l | 15 |
| Numero compressori - Compressor number - Anzahl Verdichter - Nombre compresseurs | # | 3 |
| Circuiti frigoriferi - Refrigerant circuits - Kältekreise - Circuits frigorifiques | # | 1 |
| Potenza motore - Motor power - Motorleistung - Puissance moteur | HP | 3,0 |
| Costruttore - Manufacturer - Hersteller - Fabricant | | DWM Copeland |
| Modello - Model - Typ - Modèle | | ZF 09 K4E |

Resa frigorifera totale in kW - Total cooling capacity rating in kW
Gesamtkälteleistung des in kW - Puissance frigorifique totale en kW

| t _c | t _e | | | | Condizioni operative - Operating conditions* |
|----------------|----------------|-------|------|------|---|
| | -20 | -25 | -30 | -35 | |
| +30 | 12,36 | 10,11 | 8,19 | 6,57 | 20 °C temperatura gas aspirato; 0 K sottoraffreddamento |
| +40 | 10,86 | 8,91 | 7,26 | 5,85 | 20 °C suction gas return; 0 K liquid subcooling |
| +50 | 9,21 | 7,59 | 6,21 | 5,01 | 20 °C sauggas temperatur; 0 K flüssigkeitsunterkühlung |
| | | | | | 20 °C gaz aspirés; 0 K sous-refroid. de liquide |

Dati elettrici globali - Global electric datas - Elektrische Gesamtwerte - Données électriques globales

| | | |
|--|----------|-----------------------|
| Alimentazione - Power supply - Anschluß - Alimentation | V/~ / Hz | 400 / 3+N / 50 |
| Potenza max. ass. - Max. abs. power - Max. Leistungsaufn. - Puissance max.abs. | kW | 6,62 |
| Corrente max. ass. - Max. abs. current - Max. Stromaufn. - Courant max.abs. | A | 19,5 |

* Resa frigorifera come dichiarato dai costruttori dei compr. secondo ISO 12900 - Cooling capacity as indicated by the compress. manufactures according to ISO 12900
Kälteleistung gemäß Herstellerangaben nach ISO 12900 - Puissance frigorifique coome indiqué par les constructeurs des compresseurs selon ISO12900

LT CP SN

-37/ +45 °C subcooling 3°C; superheating 10°C

| Modello Model Modell Modelle | Compressore Compressor Compresseur | Q -30/+40°C R404A [kW] | P max 400V - 3+N - 50Hz [kW] | I max [A] | Datii dimenzionali - Dimensional datae Dimensional datan - Dimensional données | | | | Connessioni frigorifere - Refrigerant connections Kälteleitungsanschlüsse - Connexions frigorifique | | | | |
|---------------------------------------|--|---------------------------------|------------------------------------|--------------|---|-----------|-----------|-----------|--|----------------------|--------------------|------------------|--------------------|
| | | | | | Structure | A [mm] | B [mm] | H [mm] | Weight [kg] | To condenser [mm] | From cond. [mm] | To users [mm] | From users [mm] |
| LT CP 2X3 SN | ZF09 K4E | 3,00 | 4,42 | 13,0 | BA | 1.750 | 800 | 1.460 | 582 | 22 | 12 | 12 | 28 |
| LT CP 2X4 SN | ZF13 K4E | 4,46 | 5,89 | 16,8 | BA | 1.750 | 800 | 1.460 | 626 | 22 | 12 | 12 | 28 |
| LT CP 2X5 SN | ZF15 K4E | 5,22 | 7,36 | 21,4 | BA | 1.750 | 800 | 1.460 | 747 | 22 | 16 | 16 | 35 |
| LT CP 2X6 SN | ZF18 K4E | 6,26 | 8,63 | 27,6 | BA | 1.750 | 800 | 1.460 | 890 | 28 | 16 | 16 | 35 |
| LT CP 3X3 SN | ZF09 K4E | 4,47 | 6,62 | 19,5 | BA | 1.750 | 800 | 1.460 | 757 | 22 | 12 | 12 | 35 |
| LT CP 3X4 SN | ZF13 K4E | 6,69 | 8,83 | 25,2 | BA | 1.750 | 800 | 1.460 | 820 | 28 | 16 | 16 | 35 |
| LT CP 3X5 SN | ZF15 K4E | 7,83 | 11,04 | 32,1 | BA | 2.100 | 900 | 1.460 | 864 | 28 | 22 | 22 | 42 |
| LT CP 3X6 SN | ZF18 K4E | 9,39 | 13,25 | 41,4 | BA | 2.100 | 900 | 1.460 | 932 | 35 | 22 | 22 | 42 |
| LT CP 4X3 SN | ZF09 K4E | 6,00 | 8,83 | 26,0 | BA | 2.900 | 1.000 | 1.460 | 1.060 | 28 | 16 | 16 | 35 |
| LT CP 4X4 SN | ZF13 K4E | 8,92 | 11,78 | 33,6 | BA | 2.900 | 1.000 | 1.460 | 1.120 | 28 | 22 | 22 | 42 |
| LT CP 4X5 SN | ZF15 K4E | 10,44 | 14,72 | 42,8 | BA | 2.900 | 1.000 | 1.460 | 1.170 | 35 | 22 | 22 | 42 |
| LT CP 4X6 SN | ZF18 K4E | 12,52 | 17,66 | 55,2 | BA | 2.900 | 1.000 | 1.460 | 1.210 | 35 | 22 | 22 | 54 |

Equilibratura olio compressori diretta - Direct compressor oil level regulation - Direkte Verdichterölniveauregulierung - Régulation directe du niveau l'huile des compresseur

Per il dimensionamento e la fornitura di condensatore ad acqua od aria remoto contattare il Ns. ufficio tecnico commerciale

For the dimensioning and the supply of the water condenser or the remote air condenser, please contact our technical-commercial office

Für die Auslegung und Lieferung wasser- oder luftgekühlter Verdichters setzen Sie sich mit unser technisch-kaufmännisches Büro in Verbindung



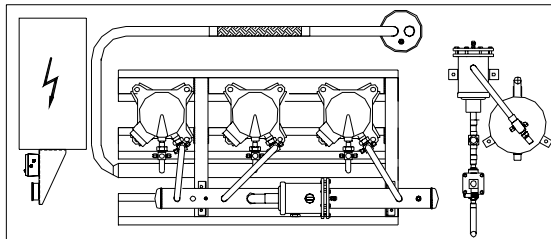
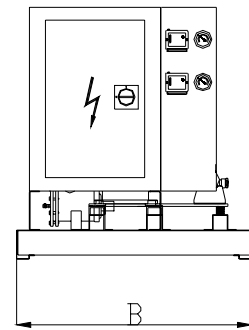
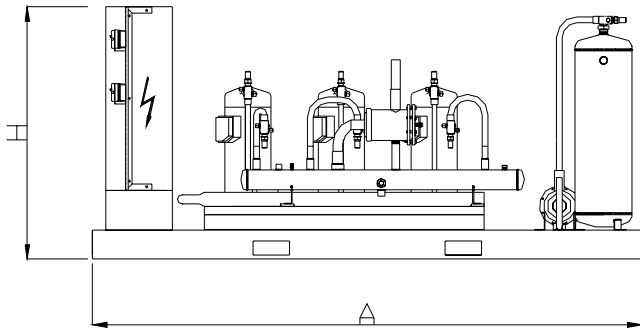



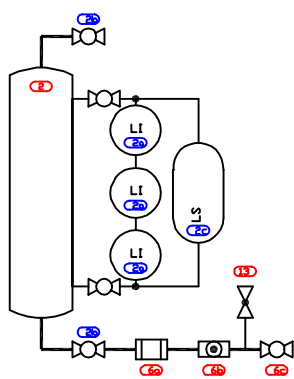
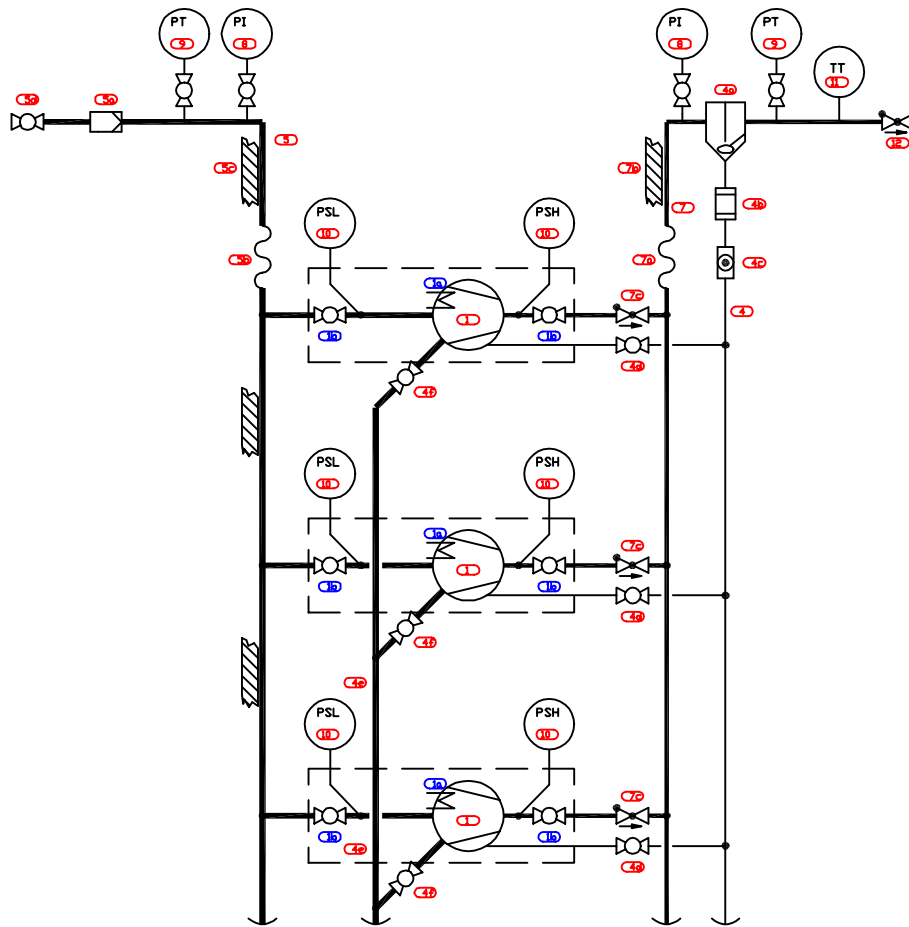



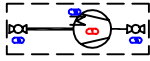









Pour la sélection et la fourniture de condenseurs à eau ou à air rémotes, contacter notre bureau technique-commercial



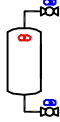







Struttura - Structure - Gehäuse - Structure " BA "



3 compressor Compressor Pack (LT & HT) - sneak concept with scroll compressors and oil equalizing

| No. | Symbol | Description |
|-----|---|----------------------------------|
| 1. |  | scroll compressor with equipment |
| 2. |  | scroll compressor |
| 3. |  | crankcase heater |
| 4. |  | rotalock valve |
| 5. |  | check valve |
| 6. |  | shut-off valve |
| 7. |  | suction filter |
| 8. |  | insulation |
| 9. |  | oil separator |
| 10. |  | sightglass |
| 11. |  | oil filter |
| 12. |  | filter-drier |
| 13. |  | liquid indicator (sight glass) |
| 14. |  | service valve |
| 15. |  | liquid receiver |
| 16. |  | temperature sensor |
| 17. |  | pressure sensor |
| 18. |  | pressure indicator |
| 19. |  | pressure switch low |
| 20. |  | pressure switch high |

Standard_compressorpacks-sneak_leg.dwg

| | | |
|-----|---|---------------------------|
| 21. |  | suction line |
| 22. |  | discharge line |
| 23. |  | liquid line |
| 24. |  | oil line |
| 25. |  | item no. |
| 26. |  | subitem no. |
| 27. |  | limits item with subitems |
| 28. |  | level switch |

Standard_compressorpacks-sneak_leg.dwg