

Unità motocondensante - Condensing unit
Verdichter-Verflüssiger-Einheit - Groupe de condensation

BA

Dimensioni - Dimensions - Maße - Dimensions	mm	2.100 x 900 x 1.260 H
Peso - Weight - Gewicht - Poids	kg	510
Ø OUT/IN evap. - Ø OUT/IN evap. - Ø AUS/EIN Verd. - Ø OUT/IN evap.	mm	54/22
Ø IN/OUT cond. - Ø IN/OUT cond. - Ø EIN/AUS Verfl. - Ø IN/OUT cond.	mm	35/28
Ricevitore di liquido - Liquid receiver - Kältemittelsammler - Bouteille de liquide	l	25
Numero compressori - Compressor number - Anzahl Verdichter - Nombre de compresseurs	#	1
Circuiti frigoriferi - Refrigerant circuits - Kältekreise - Circuits frigorifiques	#	1
Potenza motore - Motor power - Motorleistung - Puissance moteur	HP	25,0
Costruttore - Manufacturer - Hersteller - Fabricant		Bitzer
Modello - Model - Typ - Modèl		6H-25.2Y

Resa frigorifera totale in kW - Total cooling capacity rating in kW
Gesamtkälteleistung des in kW - Puissance frigorifique totale en kW

t _c	t _e				Condizioni operative – Operating conditions*
	-20	-25	-30	-35	
+30	48,50	38,90	30,70	23,60	25 °C temperatura gas aspirato; 0 K sottoraffreddamento
+40	41,50	33,00	25,70	19,53	25 °C suction gas return; 0 K liquid subcooling
+50	34,10	26,90	20,70	15,35	25 °C sauggas temperatur; 0 K flüssigkeitsunterkühlung
					25 °C gaz aspirés; 0 K sous-refroid. de liquide

Dati elettrici globali - Global electric datas - Elektrische Gesamtwerte - Données électriques globales

Alimentazione - Power supply - Anschluß - Alimentation	V~/Hz	400 / 3+N / 50
Potenza max. ass. - Max. abs. power - Max. Leistungsaufn. - Puissance max.abs.	kW	18,40
Corrente max. ass. - Max. abs. current - Max. Stromaufn. - Courant max.abs.	A	45,0

* Resa frigorifera come dichiarato dai costruttori del compr. secondo ISO 9309/8928 - Cooling capacity as indicated by the compress. manufactures according to ISO 9309/8928 Kälteleistung gemäß Herstellerangaben nach ISO 9309/8928 - Puissance frigorifique coome indiqué par les constructeurs des compresseurs selon ISO 9309/8928

Modello Model Modell Modelle	Compressore Compresor Compresseur Verdichter	Q -36/+42°C R404A [kW]	P max 400V - 3+N - 50Hz [kW]	I max [A]	Detli dimenzionall - Dimensional datae Dimensional daten - Dimensional données				Connessioni frigorifere - Refrigerant connections Kälteleitungsanschlüsse - Connexions frigorifique				
					Structure	A [mm]	B [mm]	H [mm]	Weight [kg]	To condenser [mm]	From condenser [mm]	To evaporator [mm]	From evaporator [mm]
LT CP 8 ST	4T-8.2Y	5,00	5,52	17,0	BA	1.550	800	1.260	283	28	16	12	35
LT CP 10 ST	4P-10.2Y	5,77	7,36	21,0	BA	1.550	800	1.260	335	28	18	16	35
LT CP 13 ST	4J-13.2Y	8,17	9,57	27,0	BA	1.750	800	1.260	352	28	18	16	35
LT CP 15 ST	4H-15.2Y	9,63	11,04	31,0	BA	1.750	800	1.260	370	28	22	18	42
LT CP 20 ST	4G-20.2Y	11,21	14,72	37,0	BA	1.750	800	1.260	440	28	22	18	54
LT CP 25 ST	6H-25.2Y	14,45	18,40	45,0	BA	2.100	900	1.260	510	35	28	22	54
LT CP 30 ST	6G-30.2Y	16,82	22,08	53,0	BA	2.100	900	1.460	557	35	28	28	54
LT CP 40 ST	6F-40.2Y	19,63	29,44	78,0	BA	2.100	900	1.460	609	42	28	28	54
LT CP D 2X8 ST	4T-8.2Y	10,00	11,04	34,0	BA	2.100	900	1.460	470	28	16	12	35
LT CP D 2X10 ST	4P-10.2Y	11,54	14,72	42,0	BA	2.100	900	1.460	530	28	18	16	35
LT CP D 2X13 ST	4J-13.2Y	16,34	19,14	54,0	NGA	1.980	1.040	1.625	576	28	18	16	42
LT CP D 2X15 ST	4H-15.2Y	19,26	22,08	62,0	NGA	1.980	1.040	1.625	610	28	22	18	42
LT CP D 2X20 ST	4G-20.2Y	22,42	29,44	74,0	NGA	1.980	1.040	1.625	660	28	22	18	54
LT CP D 2X25 ST	6H-25.2Y	28,90	36,80	90,0	NGA	1.980	1.040	1.625	722	35	28	22	54
LT CP D 2X30 ST	6G-30.2Y	33,64	44,16	106,0	NGA	1.980	1.040	1.625	830	35	28	28	54
LT CP D 2X40 ST	6F-40.2Y	39,66	58,88	156,0	NGA	1.980	1.040	1.625	915	42	28	28	64

Per il dimensionamento e la fornitura di condensatore ad acqua od aria remoto contattare il Ns. ufficio tecnico commerciale

For the dimensioning and the supply of the water condenser or the remote air condenser, please contact our technical-commercial office

Für die Auslegung und Lieferung wasser- oder luftgekühlter Verflüssiger setzen Sie sich mit unser technisch-kaufmännisches Büro in Verbindung

Pour la sélection et la fourniture de condenseurs à eau ou à air rémotes, contacter notre bureau technique-commercial

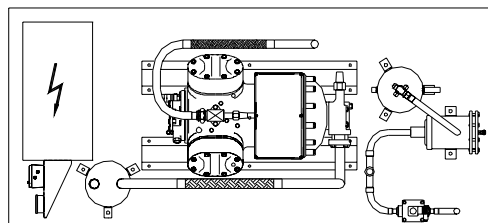
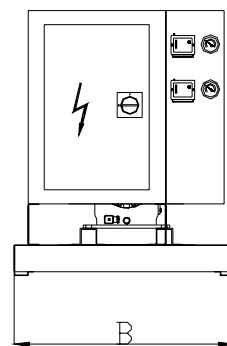
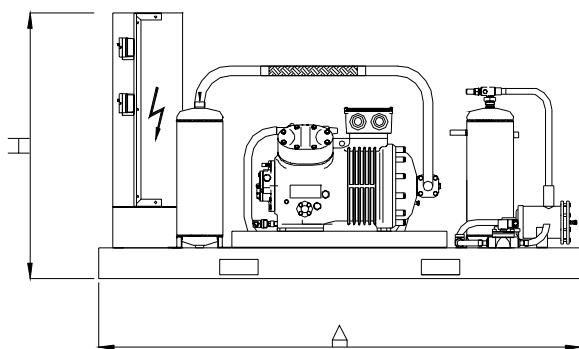

Struttura - Structure - Gehäuse - Structure " BA "

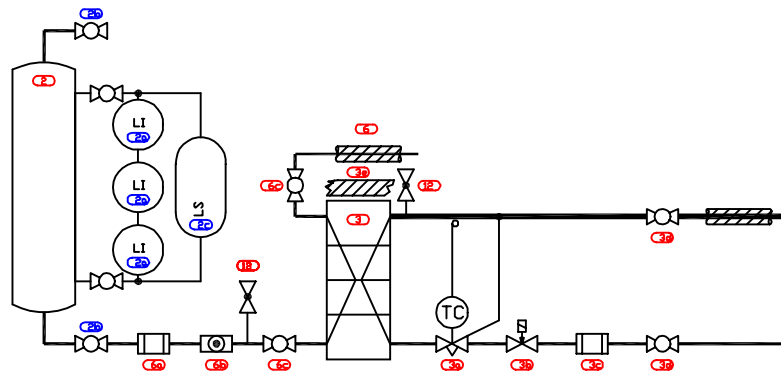
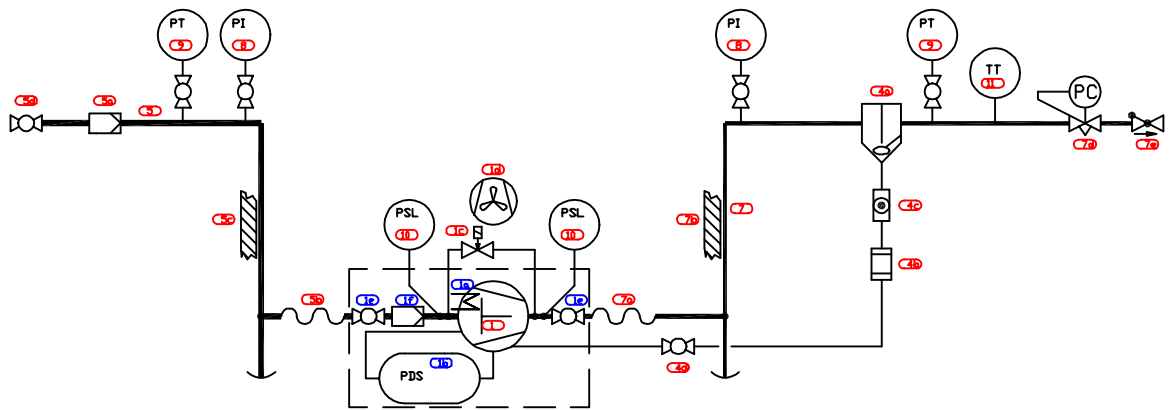

1 compressor Compressor Pack (LT)
with oil levelling system
and subcooling

No.	Symbol	Description
1.		semihermetic compressor with equipment
2.		semihermetic compressor
3.		crankcase heater
4.		rotalock valve
5.		internal suction filter
6.		pressure differential switch
7.		solenoid valve (NC)
8.		antivibrating pipe
9.		head cooling fan
10.		check valve
11.		shut-off valve
12.		suction filter
13.		insulation
13.		oil separator
15.		oil receiver
16.		pressure regulator
17.		pressure differential regulator
18.		sightglass
19.		oil filter
20.		oil level regulator

Standard_compressorpacks-leg.dwg

21.		liquid receiver
22.		thermostatic exp. valve with external pressure equalization
23.		liquid subcooler
24.		filter-drier
25.		level switch
26.		liquid indicator (sight glass)
27.		service valve
28.		temperature sensor
29.		pressure sensor
30.		pressure indicator
31.		pressure switch low
32.		pressure switch high
33.		suction line
34.		discharge line
35.		liquid line
36.		oil line
37.		item no.
38.		subitem no.
39.		limits item with subitems

Standard_compressorpacks-leg.dwg