

Unità motocondensante - Condensing unit  
Verdichter-Verflüssiger-Einheit - Groupe de condensation

**NGA**

Dimensioni - Dimensions - Maße - Dimensions	mm	<b>2.920x1.500x1.625H</b>
Peso - Weight - Gewicht - Poids	kg	<b>1.640</b>
Ø OUT/IN evap. - Ø OUT/IN evap. - Ø AUS/EIN Verd. - Ø OUT/IN evap.	mm	<b>2x64/54</b>
Ø IN/OUT cond. - Ø IN/OUT cond. - Ø EIN/AUS Verfl. - Ø IN/OUT cond.	mm	<b>64/54</b>
Ricevitore di liquido - Liquid receiver - Kältemittelsammler - Bouteille de liquide	l	<b>150</b>
Numero compressori - Compressor number - Anzahl Verdichter - Nombre compresseurs	#	<b>3</b>
Circuiti frigoriferi - Refrigerant circuits - Kältekreise - Circuits frigorifiques	#	<b>1</b>
Potenza motore - Motor power - Motorleistung - Puissance moteur	HP	<b>40,0</b>
Costruttore - Manufacturer - Hersteller - Fabricant		<b>BITZER</b>
Modello - Model - Typ - Modèl		<b>6H-40.2Y</b>

Resa frigorifera totale in W - Total cooling capacity rating in W  
Gesamtkälteleistung des in W - Puissance frigorifique totale en W

t <sub>c</sub>	t <sub>e</sub>				Condizioni operative – Operating conditions*
	0	-5	-10	-15	
+30	355.800	296.100	244.500	200.100	25 °C temperatura gas aspirato; 0 K sottoraffreddamento
+40	308.400	256.200	211.200	172.200	25 °C suction gas return; 0 K liquid subcooling
+50	257.400	213.600	175.500	142.500	25 °C sauggas temperatur; 0 K flüssigkeitsunterkühlung
					25 °C gaz aspirés; 0 K sous-refroid. de liquide

Dati elettrici globali - Global electric datas - Elektrische Gesamtwerte - Données électriques globales

Alimentazione - Power supply - Anschluß - Alimentation	V/~ / Hz	<b>400 / 3+N / 50</b>
Potenza max. ass. - Max. abs. power - Max. Leistungsaufn. - Puissance max.abs.	kW	<b>88,32</b>
Corrente max. ass. - Max. abs. current - Max. Stromaufn. - Courant max.abs.	A	<b>234,0</b>

\* Resa frigorifera come dichiarato dai costruttori dei compr. secondo ISO 9309/8928 - Cooling capacity as indicated by the compress. manufactures according to ISO 9309/8928 Kälteleistung gemäß Herstellerangaben nach ISO 9309/8928 - Puissance frigorifique coome indiqué par les constructeurs des compresseurs selon ISO 9309/8928

## MT CP ST

-10/+42 °C subcooling 3°C; superheating 10°C

Modello Model Modell Modelle	Compressore Compressor Compresseur Verdichter	Q -10/+42°C R404A [kW]	P max 400V - 3+N - 50Hz [kW]	I max [A]	Dati dimensionali - Dimensional datae Dimensional daten - Dimensional données				Connessioni frigorifere - Refrigerant connections Kälteleitungsanschlüsse - Connexions frigorifique				
					Structure	A [mm]	B [mm]	H [mm]	Weight [kg]	To condenser [mm]	From cond. [mm]	To users [mm]	From users [mm]
MT CP 2X15 ST	4P-15.2Y	49,90	22,08	62,0	NGA	1.980	1.040	1.625	580	35	22	22	2x42
MT CP 2X20 ST	4N-20.2Y	58,40	29,44	74,0	NGA	2.920	1.040	1.625	890	35	28	28	2x42
MT CP 2X25 ST	4H-25.2Y	74,60	36,80	90,0	NGA	2.920	1.040	1.625	996	42	28	28	2x42
MT CP 2X30 ST	4G-30.2Y	85,60	44,16	106,0	NGA	2.920	1.040	1.625	1.110	42	35	35	2x54
MT CP 2X35 ST	6H-35.2Y	111,90	51,52	122,0	NGA	2.920	1.040	1.625	1.280	54	35	35	2x54
MT CP 2X40 ST	6G-40.2Y	128,60	58,88	156,0	NGA	2.920	1.040	1.625	1.390	54	35	35	2x54
MT CP 2X50 ST	6F-50.2Y	153,40	73,60	184,0	NGA	2.920	1.040	1.625	1.580	54	42	42	2x64
MT CP 3X15 ST	4P-15.2Y	74,70	33,12	93,0	NGA	2.920	1.040	1.625	1.040	42	28	28	2x42
MT CP 3X20 ST	4N-20.2Y	87,60	44,16	111,0	NGA	2.920	1.040	1.625	1.170	42	35	35	2x54
MT CP 3X25 ST	4H-25.2Y	111,90	55,20	135,0	NGA	2.920	1.500	1.625	1.340	42	35	35	2x54
MT CP 3X30 ST	4G-30.2Y	128,40	66,24	159,0	NGA	2.920	1.500	1.625	1.470	64	42	42	2x54
MT CP 3X35 ST	6H-35.2Y	167,70	77,28	183,0	NGA	2.920	1.500	1.625	1.560	64	42	42	2x64
MT CP 3X40 ST	6G-40.2Y	192,90	88,32	234,0	NGA	2.920	1.500	1.625	1.640	64	54	54	2x64
MT CP 3X50 ST	6F-50.2Y	230,10	110,40	276,0	NGA	2.920	1.500	1.625	1.720	64	54	54	2x76
MT CP 4X15 ST	4P-15.2Y	99,60	44,16	124,0	NGA	3.960	1.040	1.625	1.420	42	35	35	2x54
MT CP 4X20 ST	4N-20.2Y	116,80	58,88	148,0	NGA	3.960	1.040	1.625	1.510	54	35	35	2x54
MT CP 4X25 ST	4H-25.2Y	149,20	73,60	180,0	NGA	3.960	1.500	1.625	1.680	64	42	42	2x64
MT CP 4X30 ST	4G-30.2Y	171,20	88,32	212,0	NGA	3.960	1.500	1.625	1.760	64	42	42	2x64
MT CP 4X35 ST	6H-35.2Y	223,60	103,04	244,0	NGA	3.960	1.500	1.625	1.950	64	54	54	2x76
MT CP 4X40 ST	6G-40.2Y	257,20	117,76	312,0	NGA	3.960	1.500	1.625	2.215	76	54	54	3x64
MT CP 4X50 ST	6F-50.2Y	306,80	147,20	368,0	NGA	3.960	1.500	1.625	2.380	76	64	64	3x76

Equilibratura olio con sistema AC&R - Compressor oil level regulation with AC&R system

Verdichterölniveauregulierung mit AC&R System - Régulation du niveau l'huile des compresseur avec système AC&R

Per il dimensionamento e la fornitura di condensatore ad acqua od aria remoto contattare il Ns. ufficio tecnico commerciale

For the dimensioning and the supply of the water condenser or the remote air condenser, please contact our technical-commercial office

Für die Auslegung und Lieferung wasser- oder luftgekühlter Verdichters setzen Sie sich mit unser technisch-kaufmännisches Büro in Verbindung



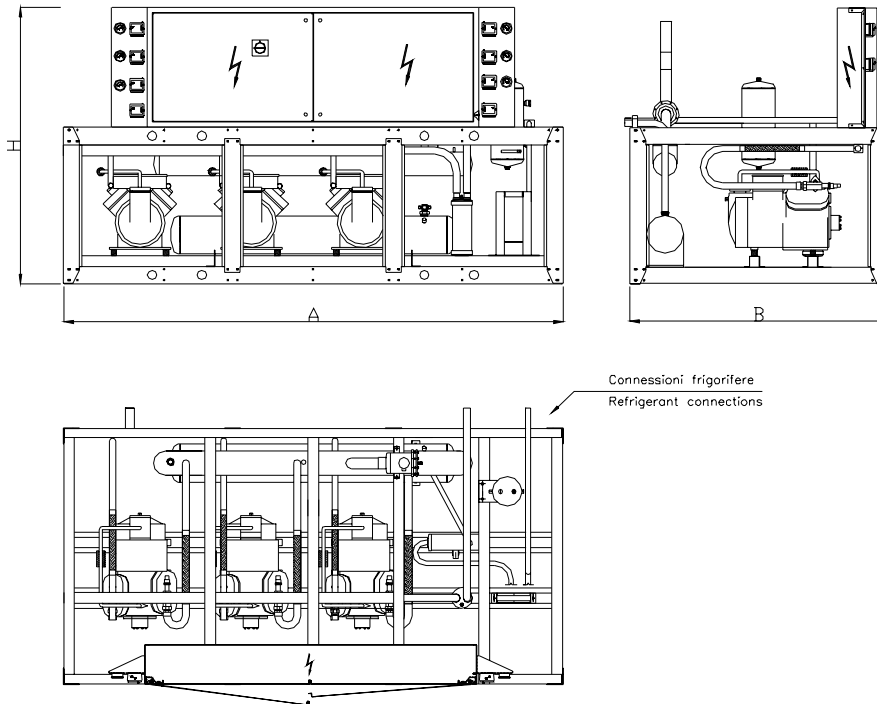



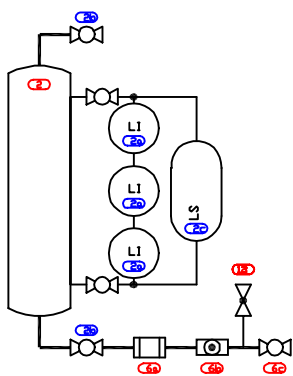
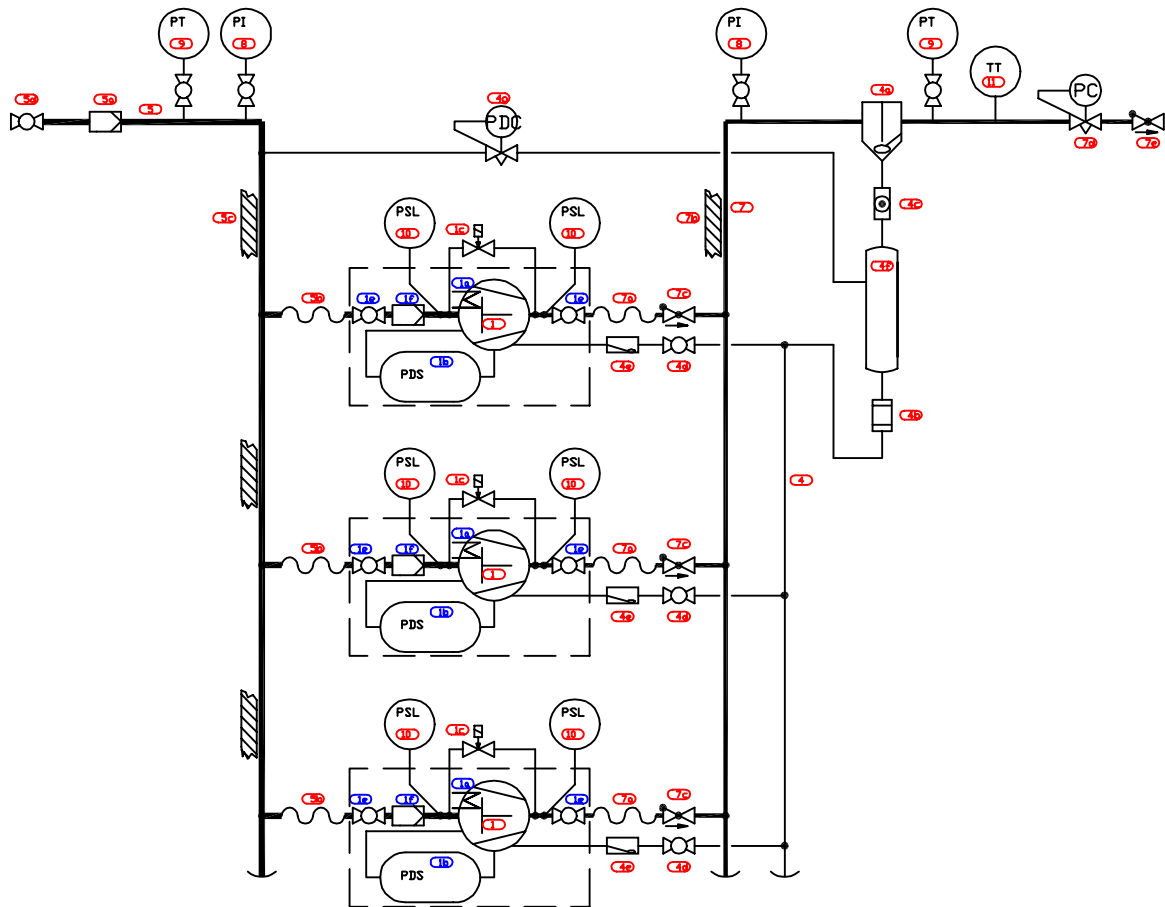



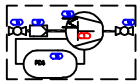









Pour la sélection et la fourniture de condenseurs à eau ou à air rémotes, contacter notre bureau technique-commercial



**Struttura - Structure - Gehäuse - Structure " NGA "**



3 compressor Compressor Pack (HT)  
with oil levelling system

No.	Symbol	Description
1.		semihermetic compressor with equipment
2.		semihermetic compressor
3.		crankcase heater
4.		rotalock valve
5.		internal suction filter
6.		pressure differential switch
7.		solenoid valve (NC)
8.		antivibrating pipe
9.		head cooling fan
10.		check valve
11.		shut-off valve
12.		suction filter
13.		insulation
13.		oil separator
15.		oil receiver
16.		pressure regulator
17.		pressure differential regulator
18.		sightglass
19.		oil filter
20.		oil level regulator

Standard\_compressorpacks-leg.dwg

21.		liquid receiver
22.		thermostatic exp. valve with external pressure equalization
23.		liquid subcooler
24.		filter-drier
25.		level switch
26.		liquid indicator (sight glass)
27.		service valve
28.		temperature sensor
29.		pressure sensor
30.		pressure indicator
31.		pressure switch low
32.		pressure switch high
33.		suction line
34.		discharge line
35.		liquid line
36.		oil line
37.		item no.
38.		subitem no.
39.		limits item with subitems

Standard\_compressorpacks-leg.dwg