

Unità motocondensante - Condensing unit
Verdichter-Verflüssiger-Einheit - Groupe de condensation

BA

Dimensioni - Dimensions - Maße - Dimensions	mm	1.750 x 800 x 1.260 H
Peso - Weight - Gewicht - Poids	kg	525
Ø OUT/IN evap. - Ø OUT/IN evap. - Ø AUS/EIN Verd. - Ø OUT/IN evap.	mm	42/22
Ø IN/OUT cond. - Ø IN/OUT cond. - Ø EIN/AUS Verfl. - Ø IN/OUT cond.	mm	28/22
Ricevitore di liquido - Liquid receiver - Kältemittelsammler - Bouteille de liquide	l	25
Numero compressori - Compressor number - Anzahl Verdichter - Nombre de compresseurs	#	1
Circuiti frigoriferi - Refrigerant circuits - Kältekreise - Circuits frigorifiques	#	1
Potenza motore - Motor power - Motorleistung - Puissance moteur	HP	25,0
Costruttore - Manufacturer - Hersteller - Fabricant		BITZER
Modello - Model - Typ - Modèl		4H-25.2Y

Resa frigorifera totale in W - Total cooling capacity rating in W
Gesamtkälteleistung des in W - Puissance frigorifique totale en W

t _c	t _e				Condizioni operative – Operating conditions*
	0	-5	-10	-15	
+30	137.800	114.600	94.600	77.400	25 °C temperatura gas aspirato; 0 K sottoraffreddamento
+40	119.400	99.100	81.600	66.400	25 °C suction gas return; 0 K liquid subcooling
+50	99.500	82.500	67.700	54.900	25 °C sauggas temperatur; 0 K flüssigkeitsunterkühlung
					25 °C gaz aspirés; 0 K sous-refroid. de liquide

Dati elettrici globali - Global electric datas - Elektrische Gesamtwerte - Données électriques globales

Alimentazione - Power supply - Anschluß - Alimentation	V~/Hz	400 / 3+N / 50
Potenza max. ass. - Max. abs. power - Max. Leistungsaufn. - Puissance max.abs.	kW	18,40
Corrente max. ass. - Max. abs. current - Max. Stromaufn. - Courant max.abs.	A	45,0

* Resa frigorifera come dichiarato dai costruttori del compr. secondo ISO 9309/8928 - Cooling capacity as indicated by the compress. manufactures according to ISO 9309/8928 Kälteleistung gemäß Herstellerangaben nach ISO 9309/8928 - Puissance frigorifique coome indiqué par les constructeurs des compresseurs selon ISO 9309/8928

MT CP ST

-10/+42 °C subcooling 3°C; superheating 10°C

Modello Model Modell Modelle	Compressore Compressor Compresseur Verdichter	Q -10/+42°C [kW]	P max 400V - 3+N - 50Hz [kW]	I max [A]	Dettaglio dimensionali - Dimensional datae Dimensional daten - Dimensional données					Connessioni frigorifere - Refrigerant connections Kälteleitungsanschlüsse - Connexions frigorifique			
					Structure	A [mm]	B [mm]	H [mm]	Weight [kg]	To condenser [mm]	From condenser [mm]	To evaporator [mm]	From evaporator [mm]
MT CP 8 ST	4Z-8.2Y	14,45	5,52	17,0	BA	1.400	700	1.260	265	22	18	16	28
MT CP 10 ST	4V-10.2Y	16,96	7,36	21,0	BA	1.550	800	1.260	370	28	18	16	35
MT CP 12 ST	4T-12.2Y	20,60	9,20	24,0	BA	1.550	800	1.260	390	28	18	16	35
MT CP 15 ST	4P-15.2Y	24,90	11,04	31,0	BA	1.750	800	1.260	465	28	22	18	35
MT CP 20 ST	4N-20.2Y	29,20	14,72	37,0	BA	1.750	800	1.260	490	28	22	22	42
MT CP 25 ST	4H-25.2Y	37,30	18,40	45,0	BA	1.750	800	1.260	525	28	22	22	42
MT CP 30 ST	4G-30.2Y	42,80	22,08	53,0	BA	2.100	900	1.460	570	35	28	22	54
MT CP 35 ST	6H-35.2Y	55,90	25,76	61,0	BA	2.100	900	1.460	630	35	28	22	54
MT CP 40 ST	6G-40.2Y	64,30	29,44	78,0	BA	2.100	900	1.460	780	35	28	28	54
MT CP 50 ST	6F-50.2Y	76,70	36,80	92,0	BA	2.100	900	1.460	887	42	35	35	64
MT CP D 2X8 ST	4Z-8.2Y	28,90	11,04	34,0	BA	1.750	800	1.460	440	22	18	16	28
MT CP D 2X10 ST	4V-10.2Y	33,92	14,72	42,0	BA	2.100	900	1.460	545	28	18	16	35
MT CP D 2X12 ST	4T-12.2Y	41,60	18,40	48,0	BA	2.100	900	1.460	570	28	18	16	35
MT CP D 2X15 ST	4P-15.2Y	49,80	22,08	62,0	NGA	1.980	1.040	1.625	880	28	22	18	35
MT CP D 2X20 ST	4N-20.2Y	58,40	29,44	74,0	NGA	1.980	1.040	1.625	910	28	22	22	42
MT CP D 2X25 ST	4H-25.2Y	74,60	36,80	90,0	NGA	1.980	1.040	1.625	990	28	22	22	42
MT CP D 2X30 ST	4G-30.2Y	85,60	44,16	106,0	NGA	1.980	1.040	1.625	1.040	35	28	22	54
MT CP D 2X35 ST	6H-35.2Y	111,80	51,52	122,0	NGA	1.980	1.040	1.625	1.160	35	28	22	54
MT CP D 2X40 ST	6G-40.2Y	128,60	58,88	156,0	NGA	1.980	1.040	1.625	1.220	35	28	28	54
MT CP D 2X50 ST	6F-50.2Y	153,40	73,60	184,0	NGA	1.980	1.040	1.625	1.370	42	35	35	64

Per il dimensionamento e la fornitura di condensatore ad acqua od aria remoto contattare il Ns. ufficio tecnico commerciale

For the dimensioning and the supply of the water condenser or the remote air condenser, please contact our technical-commercial office

Für die Auslegung und Lieferung wasser- oder luftgekühlter Verdichters setzen Sie sich mit unser technisch-kaufmännisches Büro in Verbindung

Pour la sélection et la fourniture de condenseurs à eau ou à air rémotes, contacter notre bureau technique-commercial

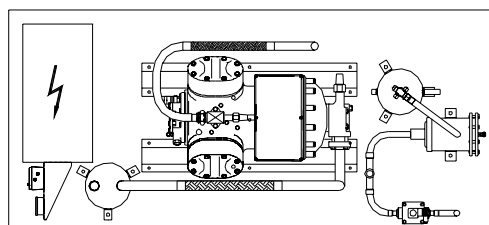
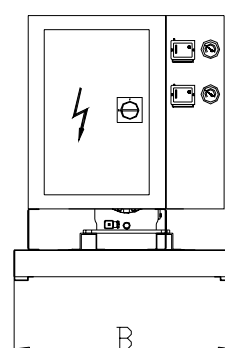
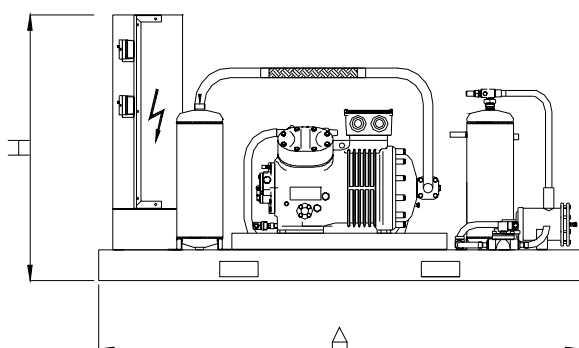



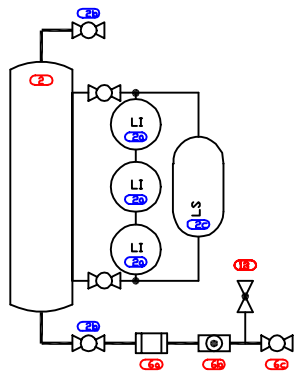
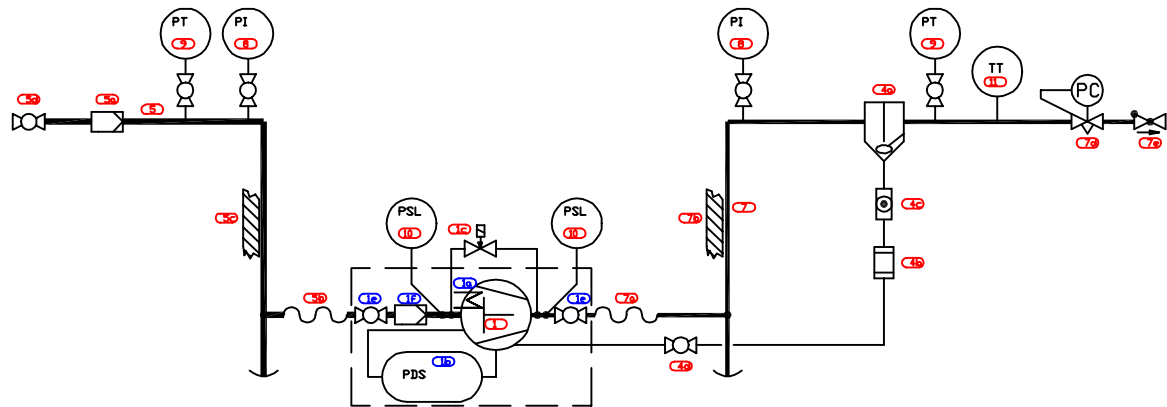







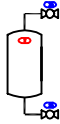







Struttura - Structure - Gehäuse - Structure " BA "



1 compressor Compressor Pack (HT)
with oil levelling system

No.	Symbol	Description
1.		semihermetic compressor with equipment
2.		semihermetic compressor
3.		crankcase heater
4.		rotalock valve
5.		internal suction filter
6.		pressure differential switch
7.		solenoid valve (NC)
8.		antivibrating pipe
9.		head cooling fan
10.		check valve
11.		shut-off valve
12.		suction filter
13.		insulation
13.		oil separator
15.		oil receiver
16.		pressure regulator
17.		pressure differential regulator
18.		sightglass
19.		oil filter
20.		oil level regulator

Standard_compressorpacks-leg.dwg

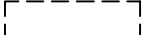
21.		liquid receiver
22.		thermostatic exp. valve with external pressure equalization
23.		liquid subcooler
24.		filter-drier
25.		level switch
26.		liquid indicator (sight glass)
27.		service valve
28.		temperature sensor
29.		pressure sensor
30.		pressure indicator
31.		pressure switch low
32.		pressure switch high
33.		suction line
34.		discharge line
35.		liquid line
36.		oil line
37.		item no.
38.		subitem no.
39.		limits item with subitems

Standard_compressorpacks-leg.dwg